

600/ 600AK WIRELESS DOORPHONE

INSTRUCTION MANUAL

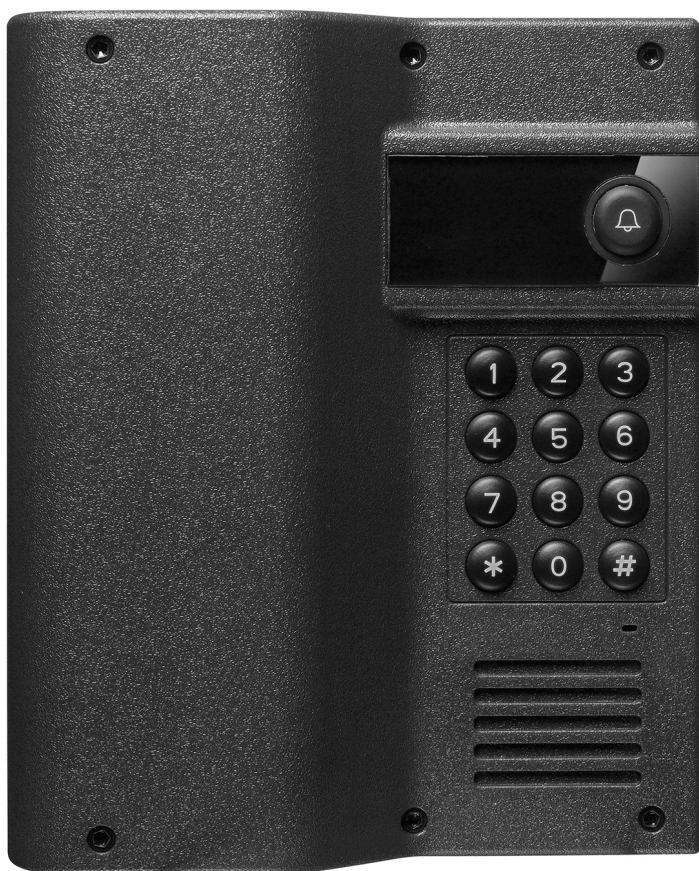

UltraCom →

Thank you for purchasing this Digital Wireless Doorphone System. Your system has been manufactured and checked under the strictest possible quality control to ensure that each system leaves the factory in perfect condition. In the unlikely event you find any defect or experience any problem, please contact our service center or dealer, do not attempt to repair by yourself.

Please read this manual carefully to obtain optimum performance and extended service life from the system.

Features

- Digital transmission ensure interference free conversation
- Two way communication
- Long operating range of 800m in open space
- Selectable audio, visual or vibration alert for doorbell
- Indication of indoor temperature
- Remote control of electric door lock
- Audible and visual alert for low battery level
- Intercom function between handsets
- Caller unit complies to IP54 standard
- Extremely easy installation without any wiring needed
- Option to use external antenna to increase the operating range
- Optional key pad on caller unit for direct access to door lock

Standard Accessories

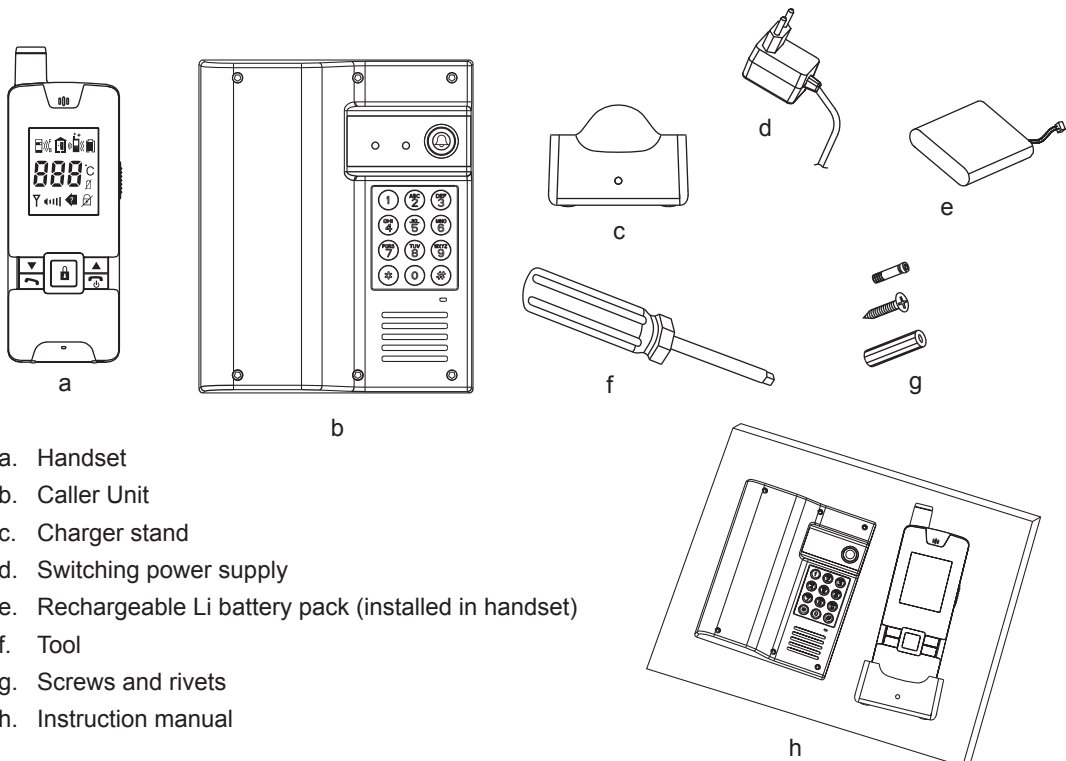

- Handset
- Caller Unit
- Charger stand
- Switching power supply
- Rechargeable Li battery pack (installed in handset)
- Tool
- Screws and rivets
- Instruction manual

Getting Started

A. Power Supply

Caller unit

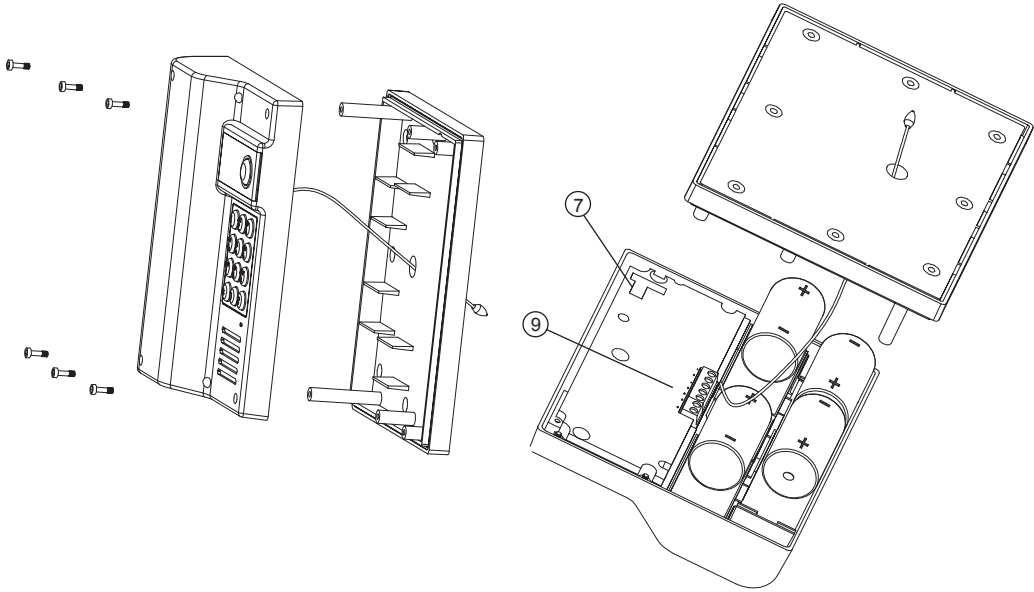



1. With the supplied tool, loosen the 6 screws that hold the unit from mounting bracket. The screws are made special for anti-theft purpose, it is necessary to keep the tool in safe place as you need it later when replacing batteries. Insert four UM-2 (C type) alkaline batteries into battery compartment, observe correct polarity.
2. Alternatively, the caller unit can operate with 12V DC supply if such supply is available at the entrance. Connect the DC supply to the terminals (9) at the back marked with $\square_{12V\ DC}$.
3. Set the switch (7) to the type of power supply (Alkaline battery BAT or 12V DC supply) you have selected.

CAUTION  : Either install alkaline batteries or connect to 12V DC supply but **NOT** both, otherwise the unit may not operate normally.

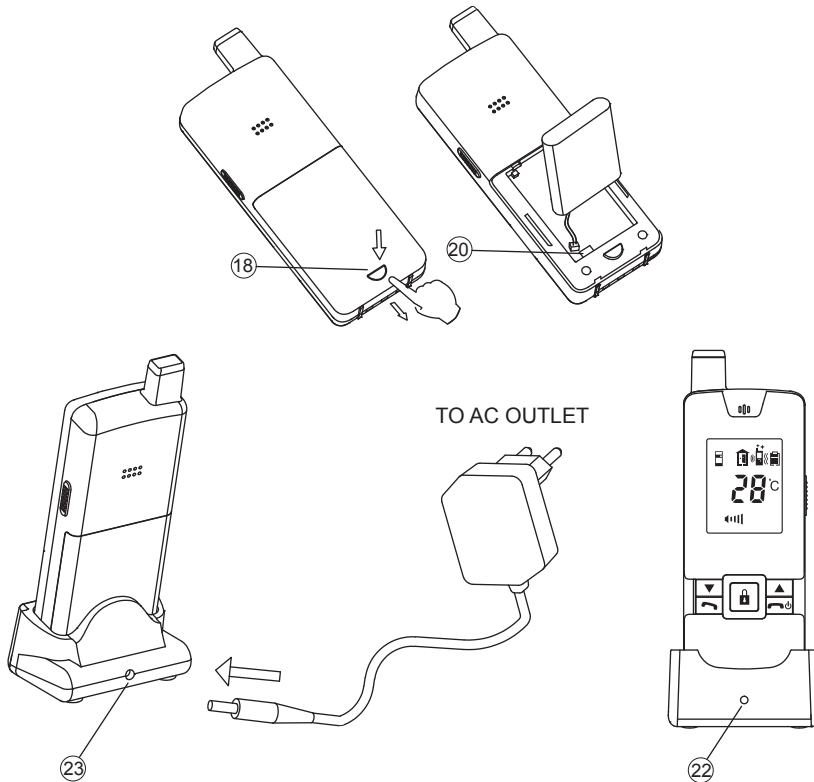
Handset



1. The supplied Lithium polymer battery pack is already installed in the handset. To replace battery, press down the lock button (18) and slide open the battery door, take out the battery and disconnect from to socket (20).
2. With the handset switched on, place it into the charger stand.
3. Plug in the supplied AC switching power supply into an AC outlet and connect its output plug to the DC jack (23) located at the back of charger stand.
4. The charging indicator (22) should light up red during charging process. Adjust the position of handset in charger stand in case this indicator does not light up. During charging, the segments inside battery level icon P  will flash in turn.
5. The battery pack should be fully charged up within 4 hours when used for the first time. All segments inside the icon P  will shown up and remain steady.
6. Now the unit is ready for operation. Either take out the unit or keep placing it in the charger stand will cause no damage to the battery. In the latter case, when the battery is being consumed and voltage falls to a certain level, the charger stand will automatically charge up the battery. The segments inside the icon P  will flash in turn whenever the unit is under charging.







CAUTION : BESURE THE BATTERY IN HANDSET IS RECHARGEABLE TYPE BEFORE YOU PLACE IT IN THE CHARGER STAND, OTHERWISE EXPLOSION MAY RESULT.

B. Pairing the Handset and Caller unit







This process is to match the caller unit with handset so that they can communicate with each other while no other devices (even doorphone of identical model) can interfere with you or receiving your signal.

The caller unit and handset are already paired with factory preset code when they are shipped from factory. However, we recommend to perform pairing again to achieve better privacy and to avoid false triggering of door lock from nearby doorphone system.

To perform pairing process, it is necessary to use alkaline batteries as power supply in the caller unit while the 12V DC supply should be disconnected temporarily.

1. Place the caller unit and handset close to each other within a distance of 1m.
2. With the handset in switch off mode, press and hold Power ON/OFF button  and door lock open button  together for around 3 sec to enter pairing mode. The LCD will become backlighted and show a flashing letter “ P ”.
3. Set the switch  to position F for caller unit intended to be used in frontgate. Press and hold the pairing button  at back, then press and hold the Call button . The call indicator  will start flashing after 3 sec, showing that the caller unit has entered pairing mode.

Perform same for the caller unit that is intended to be used in backgate (the switch  is set to position B).

4. Now release both pairing button  and Call button . Press again pairing button  on the frontgate caller unit (DO NOT press pairing button on the backgate caller unit) . Two “Di Di” sound will be heard and at the same time, the letter “ P ” and ^F (or _B)^F in case there is a backgate caller unit) will show steady in LCD of handset once pairing is successful. The call indicator  on both frontgate & backgate caller unit should stop flashing and remain steady on.
5. Long press the Power ON/OFF button  to switch off handset. Take out the alkaline batteries from caller unit and then re-install again or connect to the 12V DC supply.
6. The doorphone is now ready for operation.

If the pairing process is not successful (the “ P ” continues to flash in LCD of handset), repeat the procedures from step 1 again.

N.B. In case you are having two or more handsets as well as backgate caller unit, always perform pairing process with all caller units and handsets together and with the handsets being set in pairing mode first.

Remember every time you add on new units to the system, either handset or caller unit (for backgate use), it is necessary to perform the pairing process all over again with all the units together or otherwise the new units will not work with your original system.

C. Mounting of Caller Unit

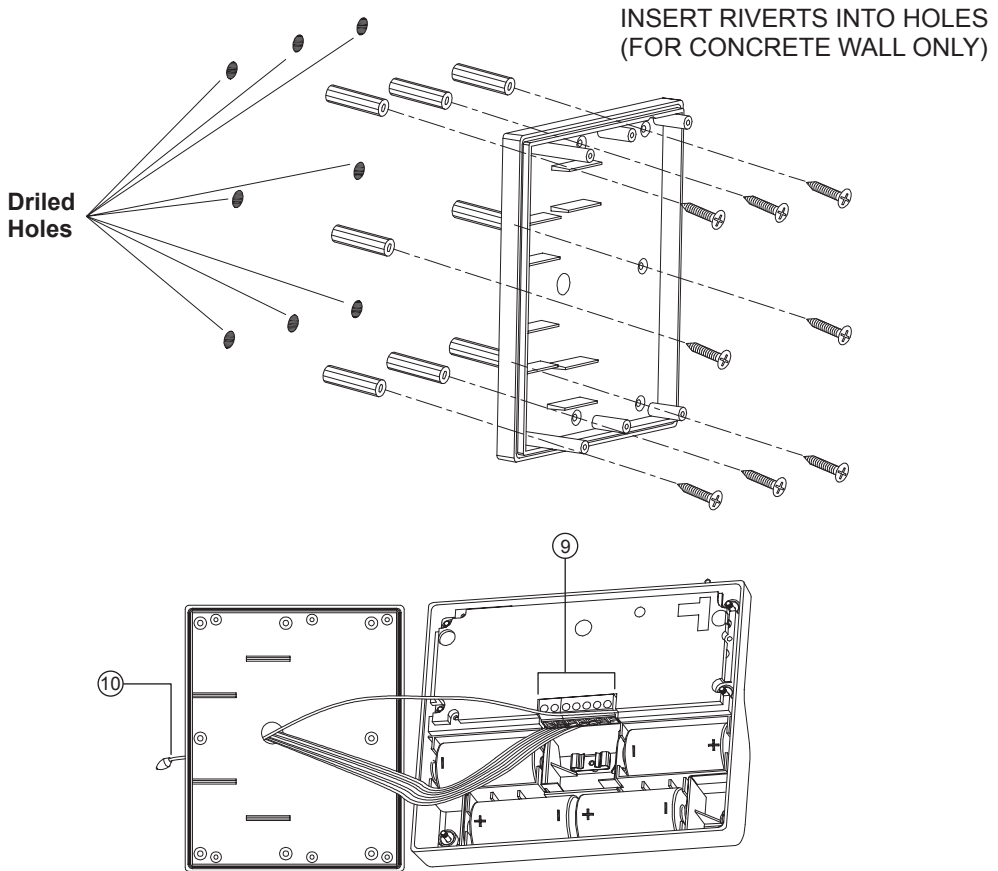

1. Select a location near your door entrance where the surface is not so rough. We recommend do some polishing to get a plane surface or otherwise the unit may not be able to mount properly.

It should be noted that the mounting bracket is not installed on metal screening surfaces nor in the vicinity of other electronic devices that may reduce the operating range. Using the supplied self tap screws, fixed the mounting bracket onto the wall.

2. Set the switch (7) to either BAT (Alkaline batteries) or DC 12V corresponding to the type of power supply you prefer. Remember to use only ONE type of power supply or otherwise the unit will not function normally. In case 12V DC is selected, connect to the terminals marked $\downarrow_{12V DC}$ at the back of caller unit.

N.B. Where 12V DC supply is available, the Call button (1)  and the door code entry keypad (2) will be automatically illuminated once the environment gets dark. This feature will not operate when using alkaline batteries so as to keep long battery life.

3. There are also terminals marked $\begin{matrix} A & B \\ \downarrow & \downarrow \end{matrix}$ and $\begin{matrix} A & C \\ \downarrow & \downarrow \end{matrix}$ for connection to an electric door latch which can be remotely opened by the handset..

CAUTION : When using DC 12V supply, in case the electric door latch does not function, reverse the polarity connected to $\downarrow_{12V DC}$ and try again.

The operation of two most common types of electric door latch on the market are either “always close” or “always open”.

Always close 

In case 12V DC supply is used, these two terminals normally provide a 12V. During communication, once the door lock opening button (13)  is pressed, this voltage will drop to 0V temporarily for 3 seconds.

In case Lithium batteries are used, these two terminals will stay at 0V normally or when button (13)  is pressed.

Always open 

These two terminals normally provide 0V. During communication, once the door lock opening button (13)  is pressed, the terminals will provide a 12V temporarily for 3 seconds.

Under no circumstances should AC mains Voltage be directly connected to the terminal blocks (9).

Auxiliary terminal 

These two terminals act like a switch and will be short circuited for around 2 sec once the call button (1)  is pressed. However, there is no voltage supply from the terminals. They can be used to trigger a conventional door chime or a courtesy light at the entrance.

4. To increase the communication range, an external antenna can be connected via the external antenna cable (10). Under such circumstance, set the antenna switch (6) to EXT position. Otherwise, always set to INT position when using the internal antenna integrated inside the unit.
5. Install back the caller unit onto mounting bracket using the supplied tool.
6. The caller unit is housed in a high impact ABS/PC cabinet which can achieve professional grade ruggedness required in most outdoor application. Rubber gaskets seals around all joints keep out dust, rain, snow and spray, assuring years of reliable operation even in harsh environment. The unit meets to IP-54 standard and can operate from -20°C to 50°C.

Controls Layout

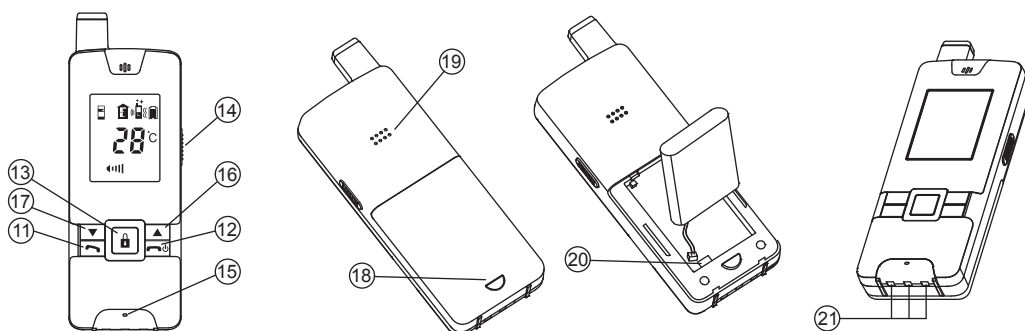
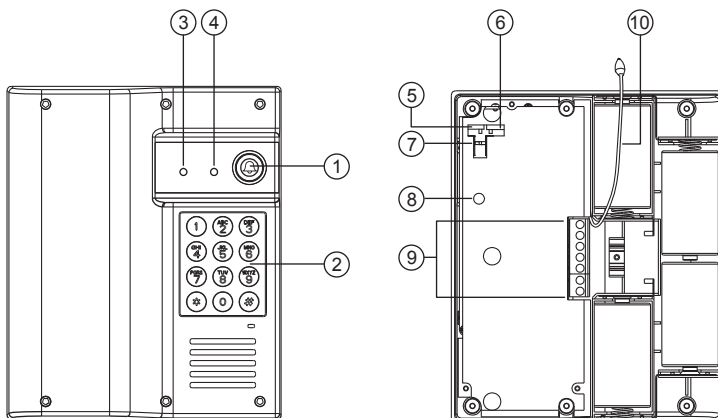

Handset

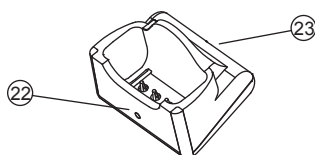

Charging Stand

- | | |
|--|--------------------------------|
| 1. Call button | 13. Door lock open button |
| 2. Door code entry keypad | 14. Press-to-talk (PTT) button |
| 3. Low battery indicator | 15. Microphone |
| 4. Call indicator | 16. Volume up button |
| 5. Front or backgate selector | 17. Volume down button |
| 6. Internal or external antenna selector | 18. Battery door lock button |
| 7. Power supply selector | 19. Speaker |
| 8. Pairing button | 20. Li battery socket |
| 9. Terminal block | 21. Charging contacts |
| 10. External antenna cable | 22. Charging indicator |
| 11. Answer button | 23. DC jack |
| 12. Hang up and power ON/OFF button | |

LCD

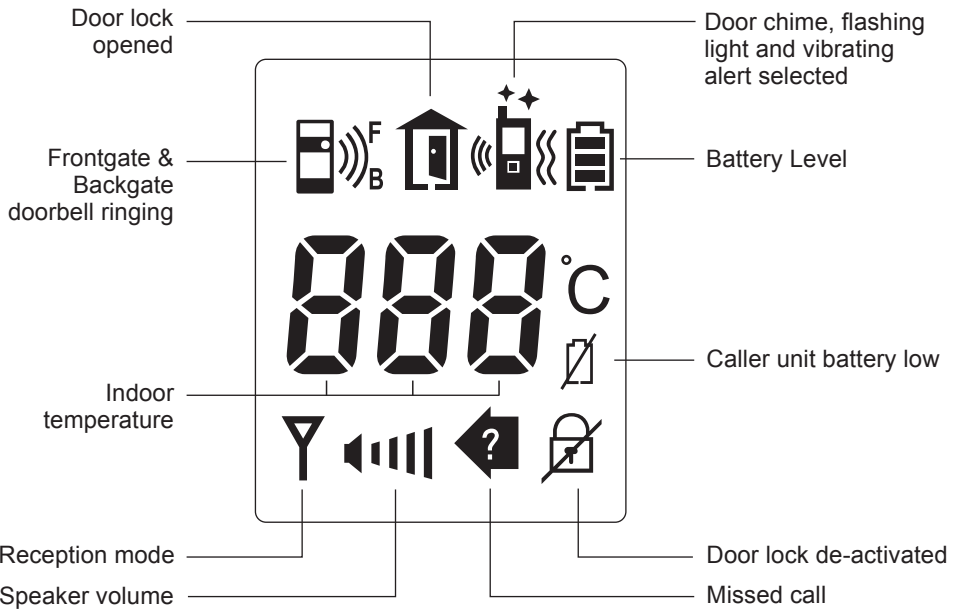









■ Flashing









■ Steady light up



- | | | | | | |
|---|--|--|---|--|--|
| A | | Frontgate doorbell ringing | J | | Door chime and vibrating alert selected |
| B | | Backgate doorbell ringing | K | | Flashing light and vibrating alert selected |
| C | | Missed call
F (Frontgate)
B (Backgate) | L | | Door chime, flashing light and vibrating alert selected |
| D | | Reception mode | M | | Door lock opened |
| E | | Door lock de-activated | N | | Caller unit battery low
F (Frontgate)
B (Backgate) |
| F | | Door chime alert selected | O | | Self battery low |
| G | | Flashing light alert selected | P | | Battery level |
| H | | Vibrating alert selected | Q | | Speaker volume |
| I | | Door chime and flashing light alert selected | | | |





OPERATION



1. Switch on the handset by a long press (over 3 seconds) of the Power ON/OFF button . Press the same button again in case you want to switch off the unit.
2. The LCD screen will show up. In case the self battery low icon  appears and an alarm heard, the battery has run down and need to be recharged by placing the unit into the charger stand. During charging, the segments inside the battery level icon  will flash in turn irrespective the unit is switched on or off. To protect battery, if the unit is not being re-charged when the icon  shown up, it will be switched off automatically after 10 minutes.
3. To select the different methods of incoming call alert, press and hold the Volume Up/Down buttons  &  simultaneously for 2 sec to enter the selection mode. Use the Volume Up  or Down button  to choose one of the seven alert methods, shortly press the Hang up button  to confirm your selection and return to normal operation mode.

Depending on your selection, either one of the icons F to L will be shown on the screen. Note that in case you select a combination with vibrating alert, the battery will run down more easily.





5. During conversation, the sound volume heard through the speaker  can also be adjusted using buttons  &  and the speaker volume icon  will change correspondingly. Please note the loudness of door chime is fixed and cannot be adjusted.
7. Make sure there is power supply to the caller unit (either by 12V DC or alkaline batteries). Now press the Call button , a ding-dong tone will be heard and the Call indicator  starts flashing. Until a handset answers the call, the ding-dong tone will be heard periodically, reminding the visitor to keep waiting. In case there is no answer after 20 seconds, the caller unit ends the call by itself and the Call indicator  goes off. Press the Call button  to initiate the call again.

N.B. In case there are two caller units (frontgate and backgate), only the unit whose call button  is first pressed will send out a call signal to handset, the remaining unit will keep in standby mode until the conversation is over. If its call button  is pressed during this period, two “Be-Be” sound will be heard and the call indicator  flashes for two times, indicating the unit is under standby mode.

8. Once the call is being answered, the Call indicator  will light up steady and the ding-dong tone stops ringing. Conversation can now be conducted.
9. Upon receiving a call, either icon A  or icon B  appears on the screen, depending the call is from the front gate or back gate (in case you have purchased an optional caller unit for back gate). The handset can answer the call by pressing the Answer button  and the reception mode icon D  will show up in LCD.



Now conversation is possible and the voice of visitor can be heard from speaker (19). To talk back to visitor, press and hold the PTT button (14) and speak towards the Microphone (15), reception mode icon D  goes off. Release PTT button (14) after finish speaking to listen to visitor, reception mode icon D  show up again. It should be worth noted that the voice of visitor will not be heard while pressing the PTT button (14). Upon finish of conversation, press the Hang up button (12)  to end the call.

This system has an automatic end call feature. In case the resident does not talk back to visitor (i.e. press the PTT button (14)) for over 90 sec, the call will be ended automatically. Such feature is useful to protect your privacy in case you forget to end the call by pressing the Hang up button (12) .

10. Once a call has been answered, you can use the Door lock open button (13)  to remotely open the electric door latch for visitor (this function only available if your door is equipped with an electric latch). Press the button (13)  shortly, wait for 4-5 seconds and the icon M  appears on the screen, showing the door latch is opened. The icon M  will disappear after 3 sec.

To avoid misuse by children, this door lock opening function can be activated or deactivated. When deactivated, pressing the button (13)  will have no effect.









Deactivate door lock opening feature

Under normal operating mode, press shortly the button (17) , then within a period of 2 sec, press shortly the button (13) . The Door lock de-activated icon E  will show up on LCD screen.

Activate door lock opening feature





Perform same procedure as above, the Door lock de-activated icon E  will disappear from the LCD screen.

11. For system equipped with several handsets, all the handsets will be alerted with an incoming call. However, only the handset which first press the Answer button (11)  can set up conversation with caller unit. The remaining handsets will return to standby mode and their buttons become de-activated until the conversation ends, making them impossible to interfere with the conversation.

12. Under the circumstances of an unanswered call from a visitor (e.g. you are away from home) the icon C  will appear on the screen. This icon is useful to remind you somebody has called. Press any button momentarily to remove this icon.
13. In case the alkaline batteries in caller unit becomes run down, once the call button  or * button is pressed, the low battery indicator  will flash for 10 sec. Besides, the icon N  appears on the screen of handset and an alarm will be heard, reminding you to replace with new batteries in the respective caller unit. Press any button momentarily can stop the alarm but the icon N  still remains until new batteries are installed.
14. The temperature indication provides you with an idea about the ambient temperature where the handset is located.
15. Whenever the buttons (except PTT button ) on handset are pressed, a tone will be heard to validate your entry.
16. Once the enviroment turns dark, the Call button  on caller unit as well as door code entry keypad  will become automatically backlighted (only if 12V DC supply is available).

Intercom

This function is applicable only if you have two or more handsets. Please note all units must be paired together.



- a. Under standby mode, momentarily press Answer button  , a “do – do” sound will be heard.
- b. The called handset will show the selected incoming call alert. Press Answer button  to answer the call. The “do-do” sound on the calling handset will stop.
- c. Now both handsets can converse with each other using the PTT button .
- d. Either party can press the Hang up button  to end the conversation.
- e. The call will also be ended automatically if the PTT buttons  on either party is not pressed for over 60 sec.

For system with more than two handsets, the incoming call alert on remaining handsets will stop once the call is being answered. In case nobody answer the call, the alert will stop 20 seconds later.

N.B. Selective call of a particular handset is not possible. Whenever an handset initiates a call, all the remaining units will be alerted and can answer to the call. However, only the unit who first press the Answer button  can reply to the call, all others will be excluded from the intercom.

CAUTION : The two handests under intercom may not be able to detect a call from the caller unit. So it is advisable to keep the intercom conversation short.

Setting of Door Lock Opening code (for unit equipped with door code entry keypad)

- a. With the handset being switched off, long press of Answer button  (11) and Hang up button  (12) at the same time for 2 sec will enter code setting mode. The LCD will show “ _ _ _ _ ”.
- b. Place the handset nearby the caller unit (preferably within 1 m apart).
- c. With the caller unit in standby mode, press * 168 to enter code setting mode. Two “Di-Di” sound will be heard.
- d. Now press a preferred four digit code. For each press of a digit, it will be shown on the handset LCD respectively followed by two “Di-Di” sound, otherwise the entry is not successful and the whole process need to be repeated again.

Note the time period between each entry of a digit should not be more than 10 sec.

- e. Long press of the Hang up button  (12) to switch off handset, then press again same button to switch it on and resume normal operation.
- f. To open door lock at gate, press *# followed by the four digit code, two “Di-Di” sound will be heard once the lock is successfully opened.
- g. Repeat above steps a – e to set a new door lock opening code.

PRECAUTION

- Use only the supplied AC adapter for charger stand. Use of other supply may cause damage to the handset.
- Do not mix using old and new alkaline batteries in caller unit.
- When not using the doorphone for a long period of time, remove all batteries from handset and caller unit to avoid battery leakage.
- Do not leave the handset expose to strong sunlight for a long period of time or near any heat source, moisture and excessive dusty environment.
- Do not open the cabinet, no serviceable parts inside.
- When using for the first time, switch off the handset and charge up the supplied battery pack for 4 – 5 hours using the charger stand.

TROUBLE SHOOTING GUIDE

Problem	Possible Causes	Solution
Handset and Caller unit cannot communicate	Handset and Caller unit has different ID code Battery has run down	Perform pairing process Replace new battery in Caller unit Recharge battery in Handset using charger stand.
Communication distance become short	Many steel structures between Handset and Caller unit Battery has run down	Relocate the position of Handset Replace new battery in Caller unit Recharge battery in Handset using charger stand.
Self battery low icon always on	Battery pack is damaged and cannot be recharged.	Replace new battery pack
Door latch cannot be remotely opened by handset	Door lock opening button (13) is deactivated Wrong connection at terminal block	Activate door lock opening button (13) Make proper connection
Cannot perform intercom between Handsets	The unit are not properly paired Battery has run down	Perform pairing process Recharge battery using charger stand
New Caller unit (backgate) cannot communicate with indoor unit	The new unit is not properly paired to existing units	Perform pairing process