



**Environmental Information for Customers in the European**

**Union** European Directive 2002/96/EC requires that the equipment bearing this symbol on the product and/or its packaging must not be disposed of with unsorted municipal waste. The symbol indicates that this product should be disposed of separately from regular household waste streams. It is your responsibility to dispose of this and other electric and electronic equipment via designated collection facilities appointed by the government or local authorities. Correct disposal and recycling will help prevent potential negative consequences to the environment and human health.

For more detailed information about the disposal of your old equipment, please contact your local authorities, waste disposal service, or the shop where you purchased the product.

## **Sales & Technical Helplines**

Our Sales & Technical helplines are open  
Monday to Friday from 8.00am to 5.00pm

### **SALES**



++44 (0)1604 589414 (and press option 1)



info@ultrasecuredirect.com

### **TECHNICAL**



++44 (0)1604 589414 (and press option 2)



technical@ultrasecuredirect.com

### **ULTRA SECURE LTD,**

9-10 RYEHILL COURT,

LODGE FARM I/E, NORTHAMPTON, NN5 7EU

UNITED KINGDOM

[www.ultrasecuredirect.com](http://www.ultrasecuredirect.com)

# UltraSecure

## PROTECT 800

### Wireless Vehicle Probe

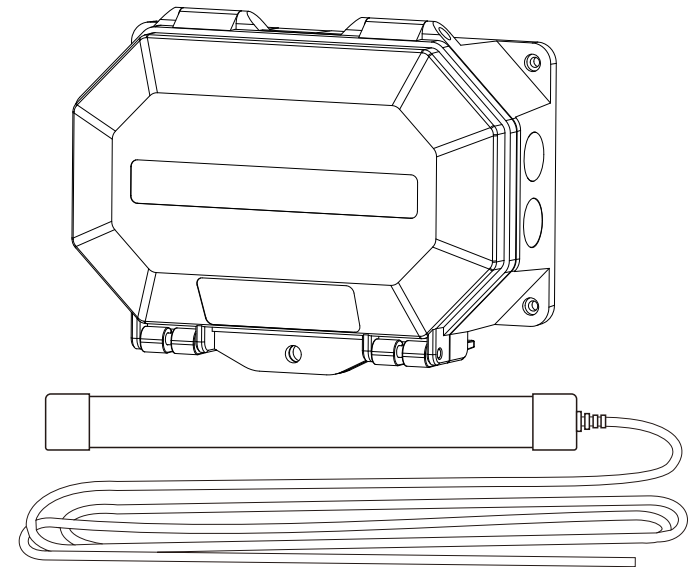

- \*\* Vehicle Detection Probe with 800m Transmission
- \*\* Adjustable Sensitivity
- \*\* N/Open Output Relay
- \*\* Compatible with other Protect 800 Equipment
- \*\* IP 56 weatherproof control Box

## User Manual

## Parts & Function

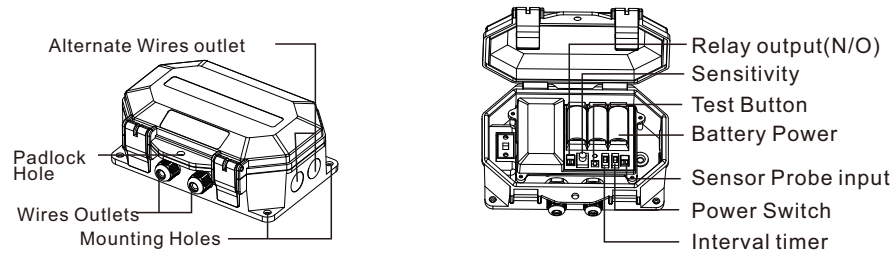

## Power

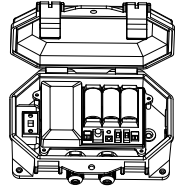

Insert 3 CR123A batteries into the battery compartment

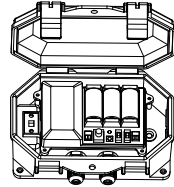

Slide the power switch to "ON" position, press the test button, the LED will light up

## Installation

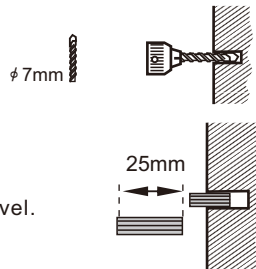
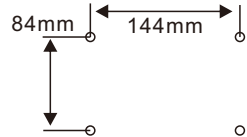
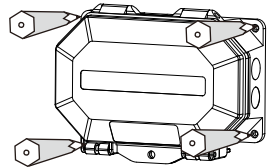

Mounting the control box at a height above any possible Flood Level.

## GSM Dialer

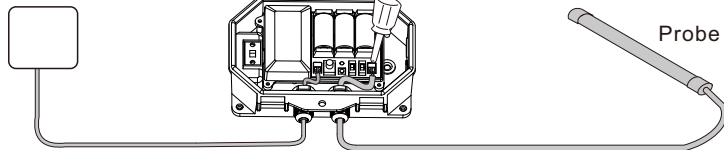

Connect the sensing probe cable to the box. The Normal Open output relay can be connect to a third party device ,such as a GSM dialer..

## Using The Alternate Outlet

You can use the alternate lower or side wire outlet to suit your installation, removing and replacing blanking plugs where not used. **The use of a silicone sealant around these outlets will increase protection from water ingress**

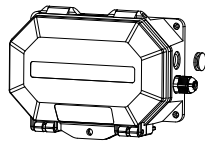
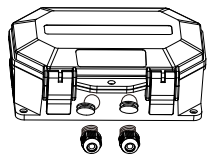

After the installation, it can be locked with a padlock to prevent outside interference.

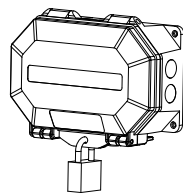

## Pairing

Set the receiver to pairing mode follow the instruction sheet of the receiver. Press the test button inside the box to pair. Then follow the instruction of the receiver to complete the operation.

## Sensitivity

You can adjust the sensitivity as needed.High sensitivity can detect longer distances, but it is more susceptible to interference and generate false triggers.

## Interval setting

You can set the trigger interval according to your needs, this is the time the system take to re-set before it can be triggered by the probe again.

## Code Conflict

If the Sensor transmitter coding is the same as another transmitter you must change the code. When you have changed the code must re-pair the bell press

- \* Slide the power switch to off position
- \* Press and hold the test button
- \* slide the power switch to on position
- \* the LED will blink slow for 5 time then blink quick
- \* Code is changed
- \* Do not forget to pair the sensor after code changed.

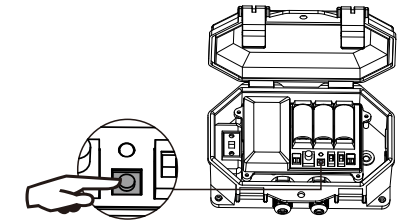
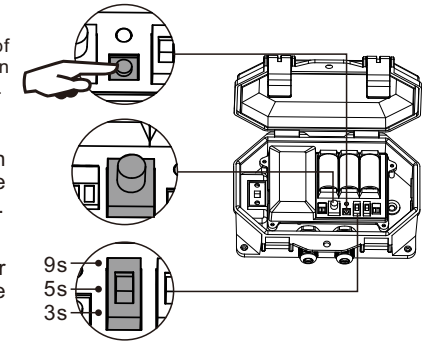

## Operation

After installation, press the test button to see if the receiver can receive the signal. If the signal is not received, change the location, reinstall or change the receiver location.

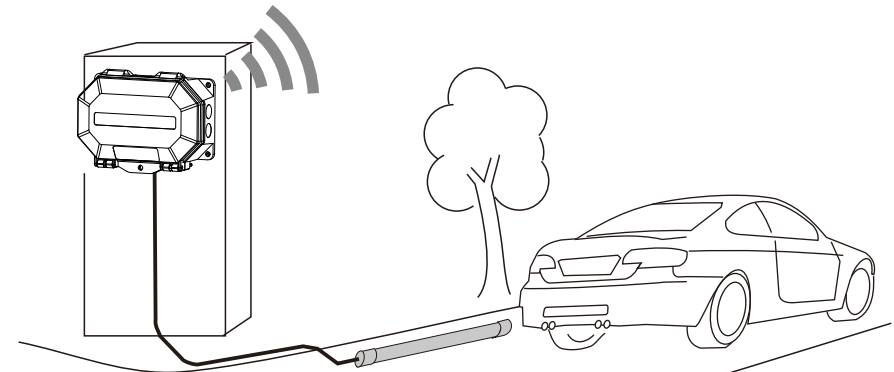

Install the sensor probe 1 - 2 inches (25 - 50 mm) under the roadside verge, with the cable inside protective tubing to prevent damage general wear or wildlife. place it in-line with thw driving direction. Adjust the sensitivity until when a car passes it will trigger the control box and without causing false triggers.